

861

600 x 480 x 2000 mm

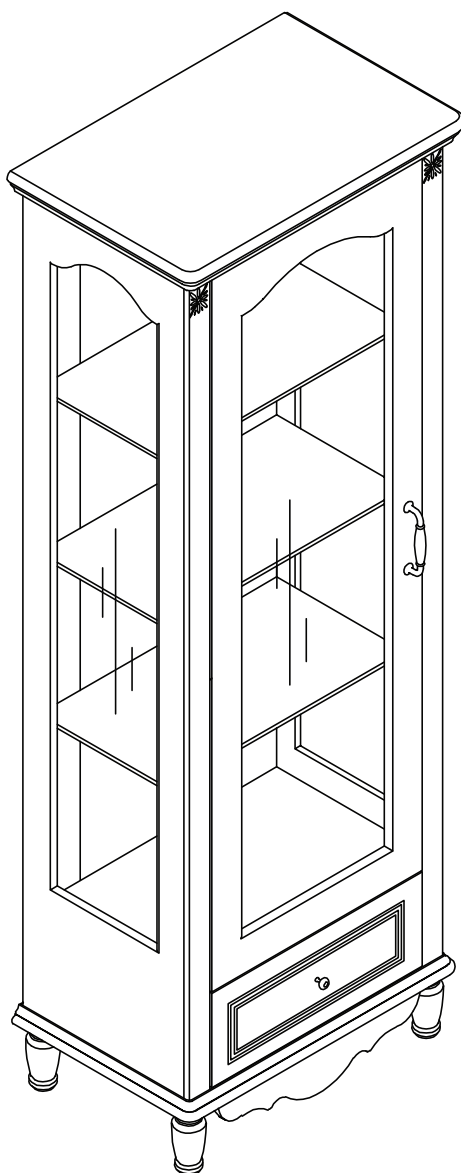

BEMONDI

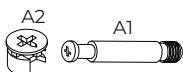
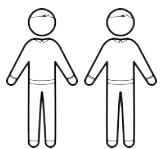
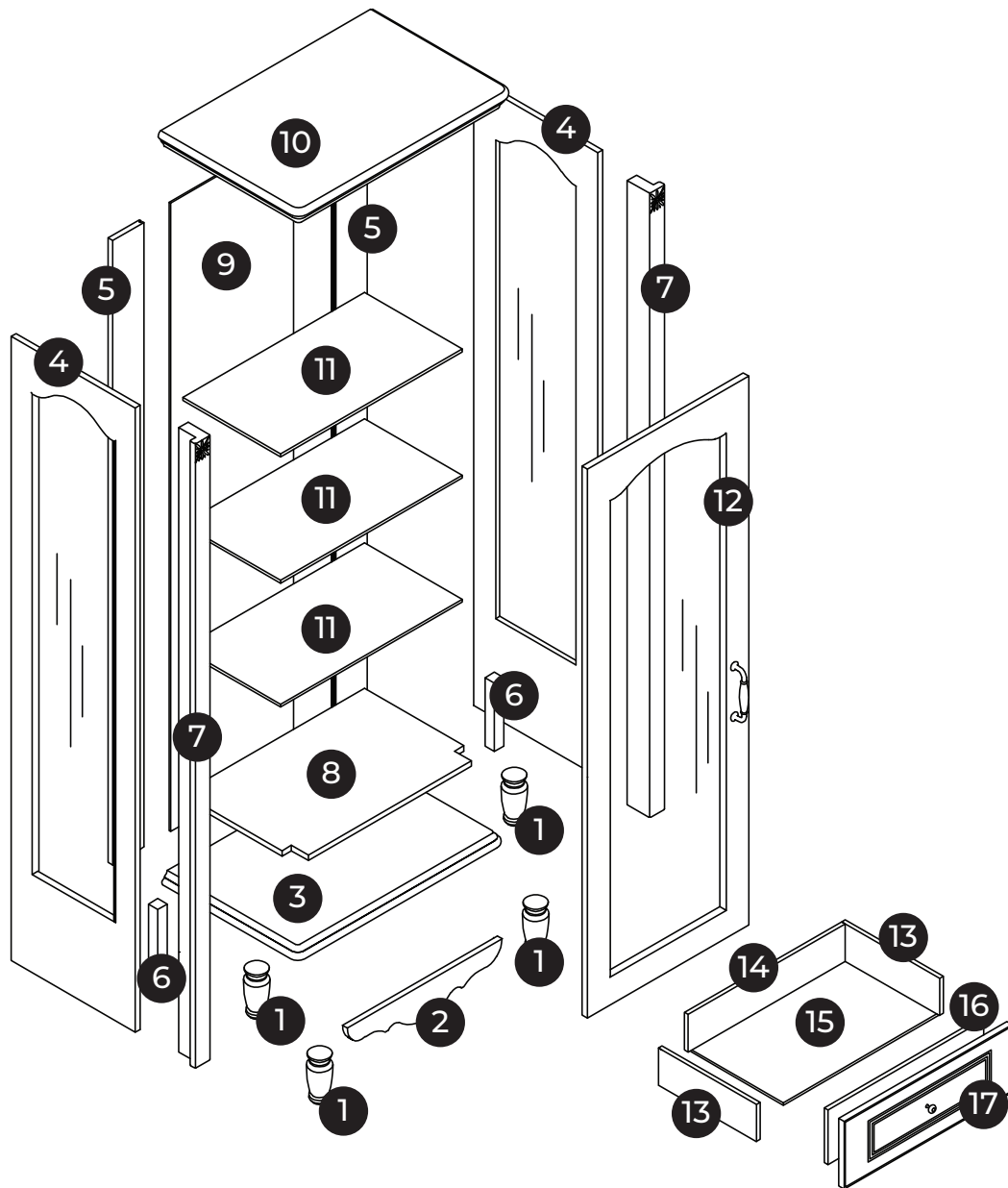

A x31
 Ø 15 mm



B x12
 Ø 8 x 30 mm

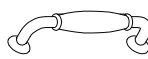

C x1



D x1



E x1
 Ø 4 x 20 mm



F x4
 Ø 3,5 x 12 mm

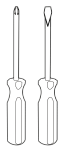

G x4
 Ø 3,5 x 15 mm

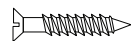

H x8
 Ø 3,5 x 35 mm

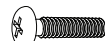

I x2
 Ø 6 x 20 mm

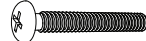

J x12
 Ø 6 x 50 mm



K x4
 Ø 8 x 50 mm



L x12
 Ø 5 x 18 mm

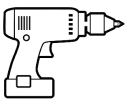

M x4



N x2
 Ø 4 x 25 mm



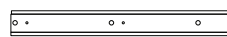

O x16
 Ø 4 x 10 mm

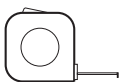

S x2
 300 x 35 mm

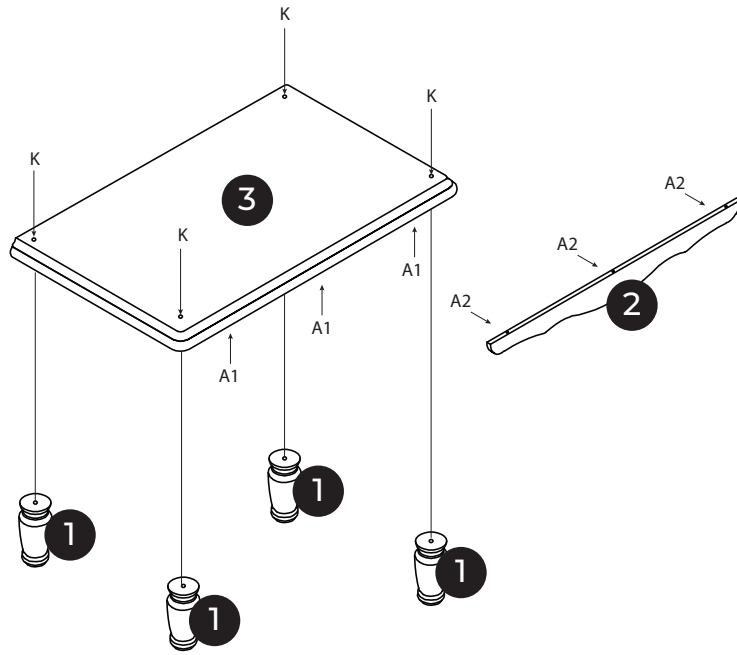
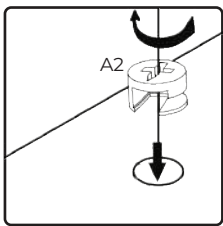
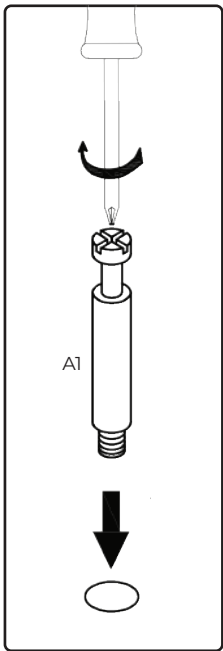

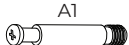

A   x3

K  x4

1

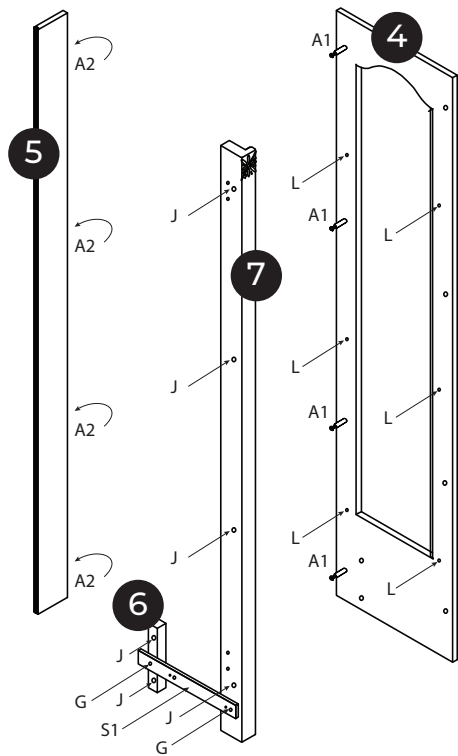
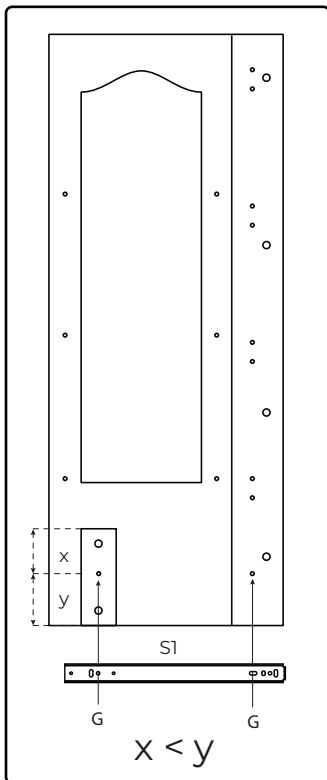

x2

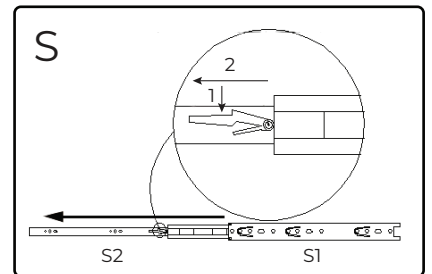

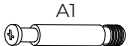

x2

A   x8

G  x4

J  x12

L  x12

S1  x2

2

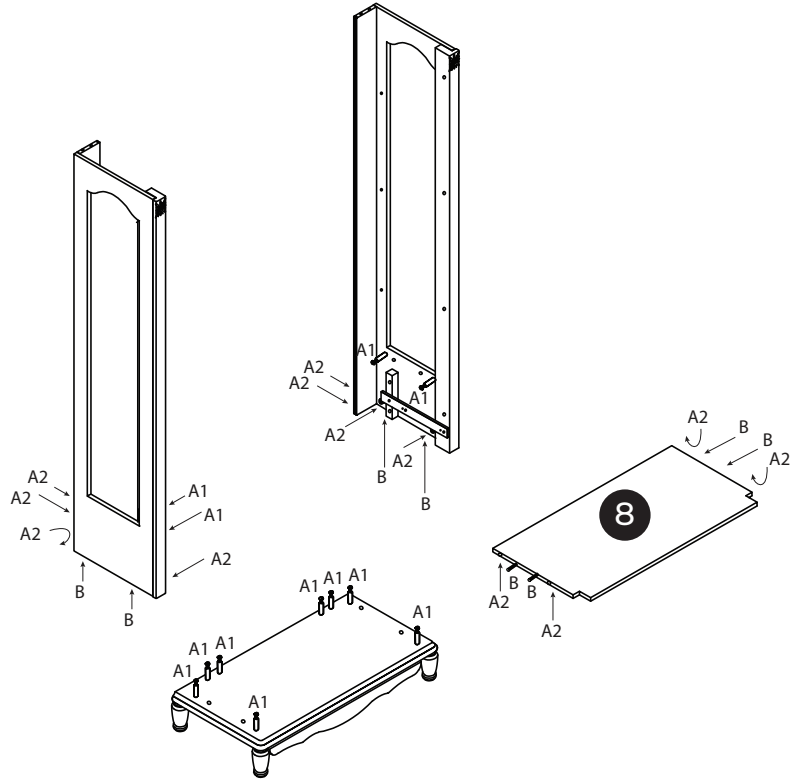
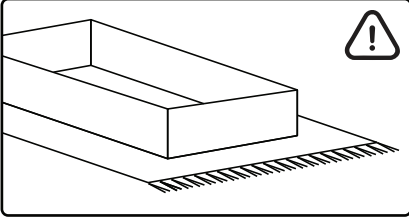

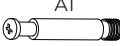
A   x12

B  x8

3

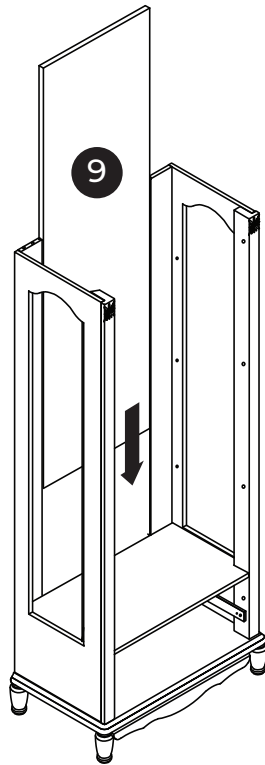
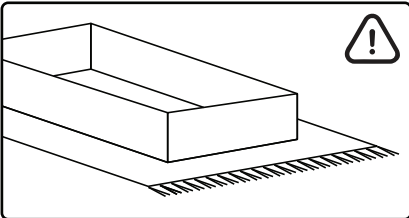

4

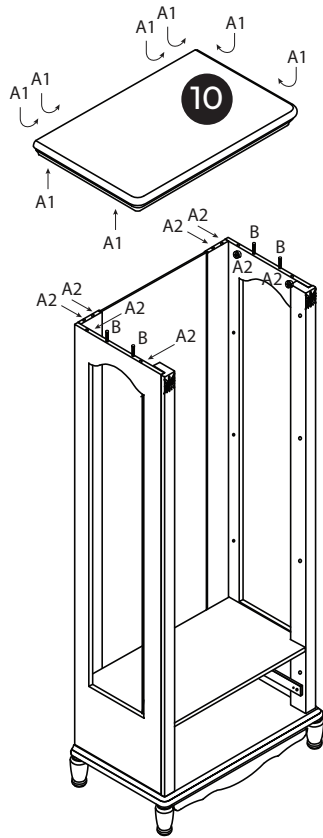
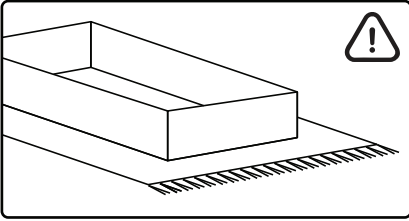

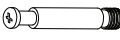
A   x8

B  x4

5

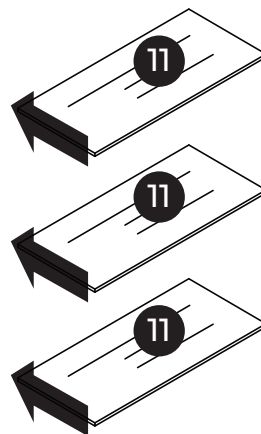
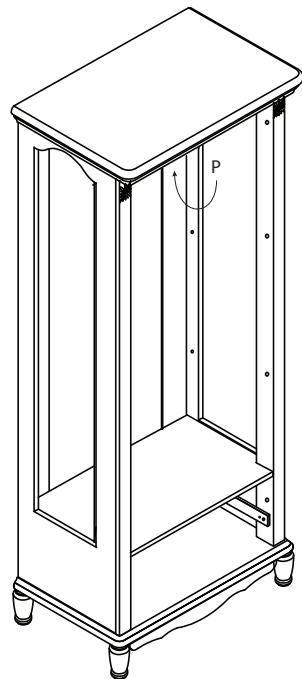

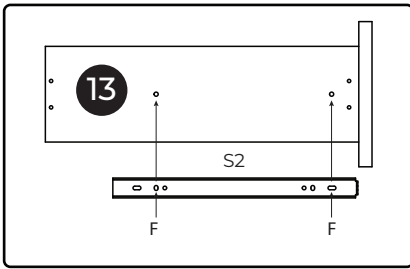

6

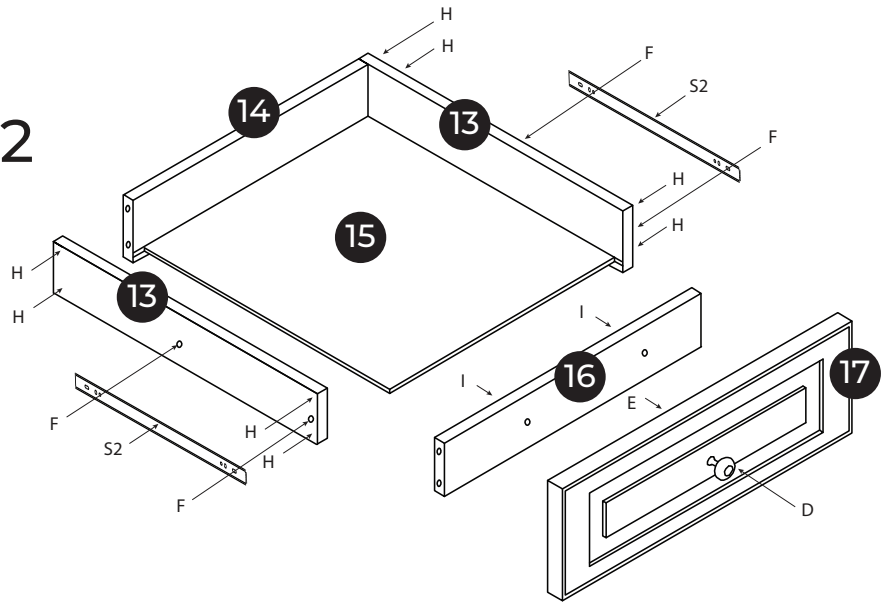
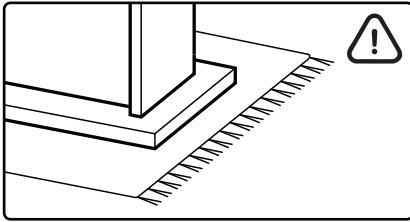

x2



D  x1

E  x1

F  x4

H  x8

I  x2

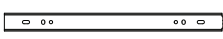
S2  x2

7

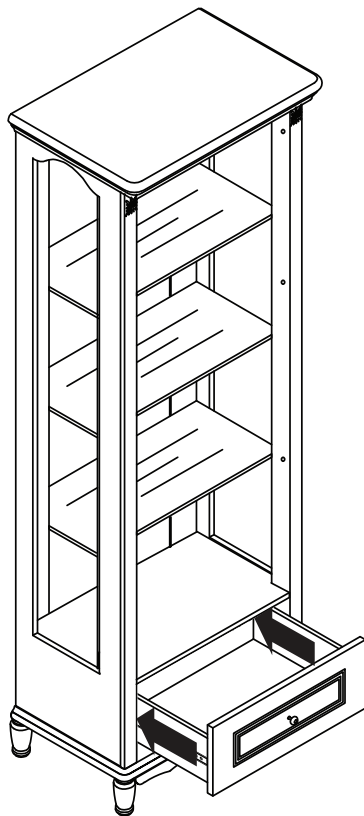

8

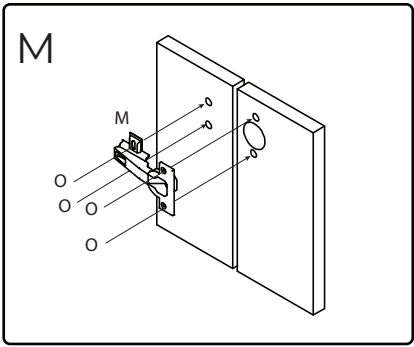

x4

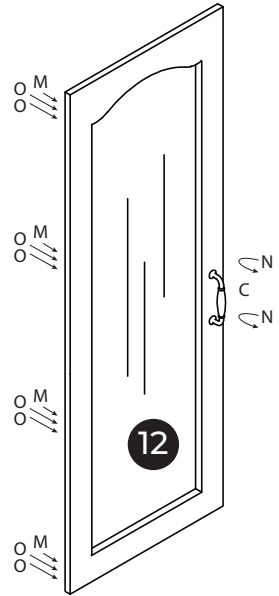
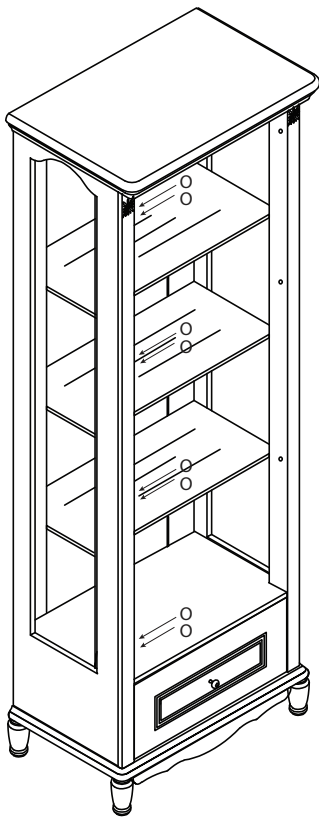

C  x1

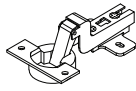
M  x4

N  x2

O  x16

9

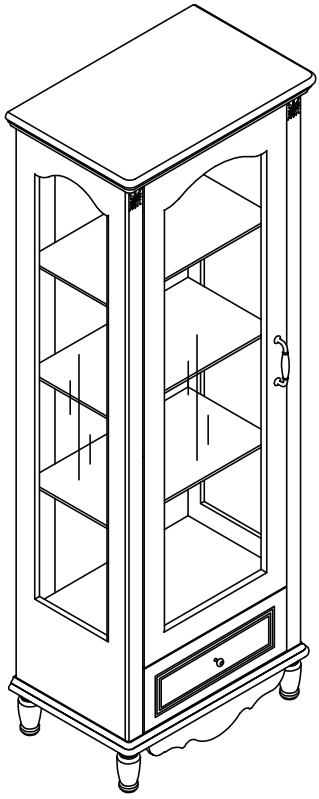

10