

# 902A

1200 x 470 x 1710 mm

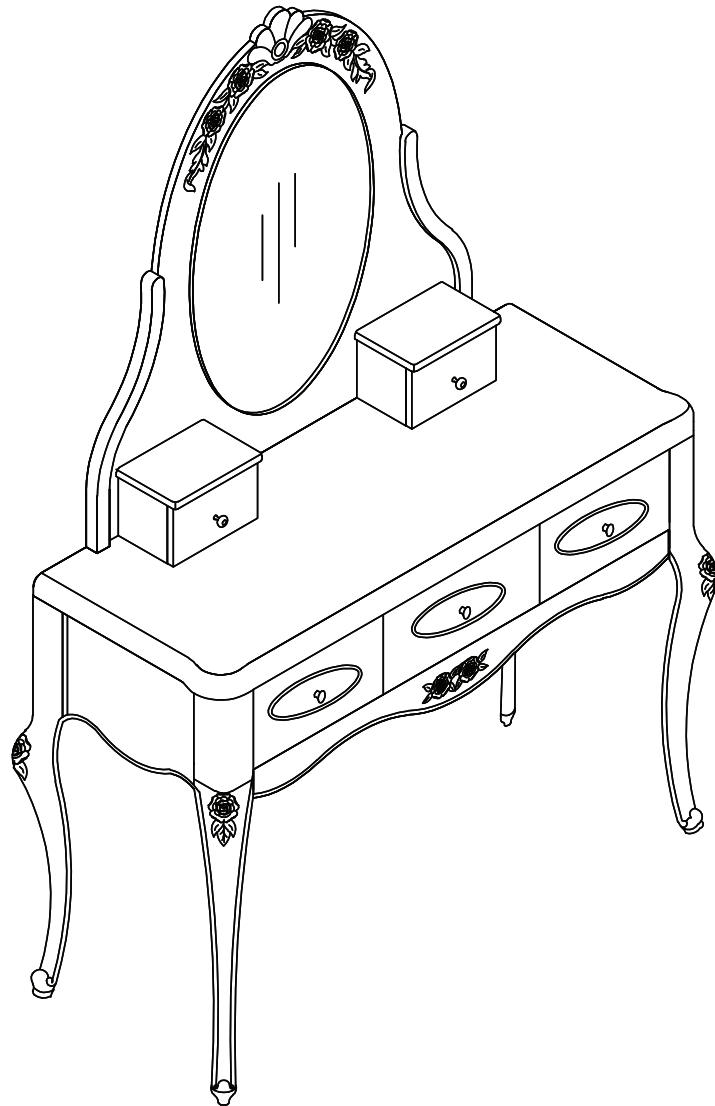

**BEMONDI**

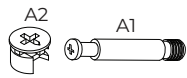
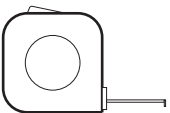
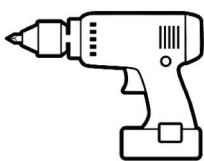
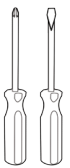
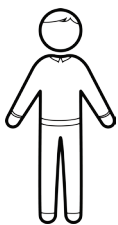
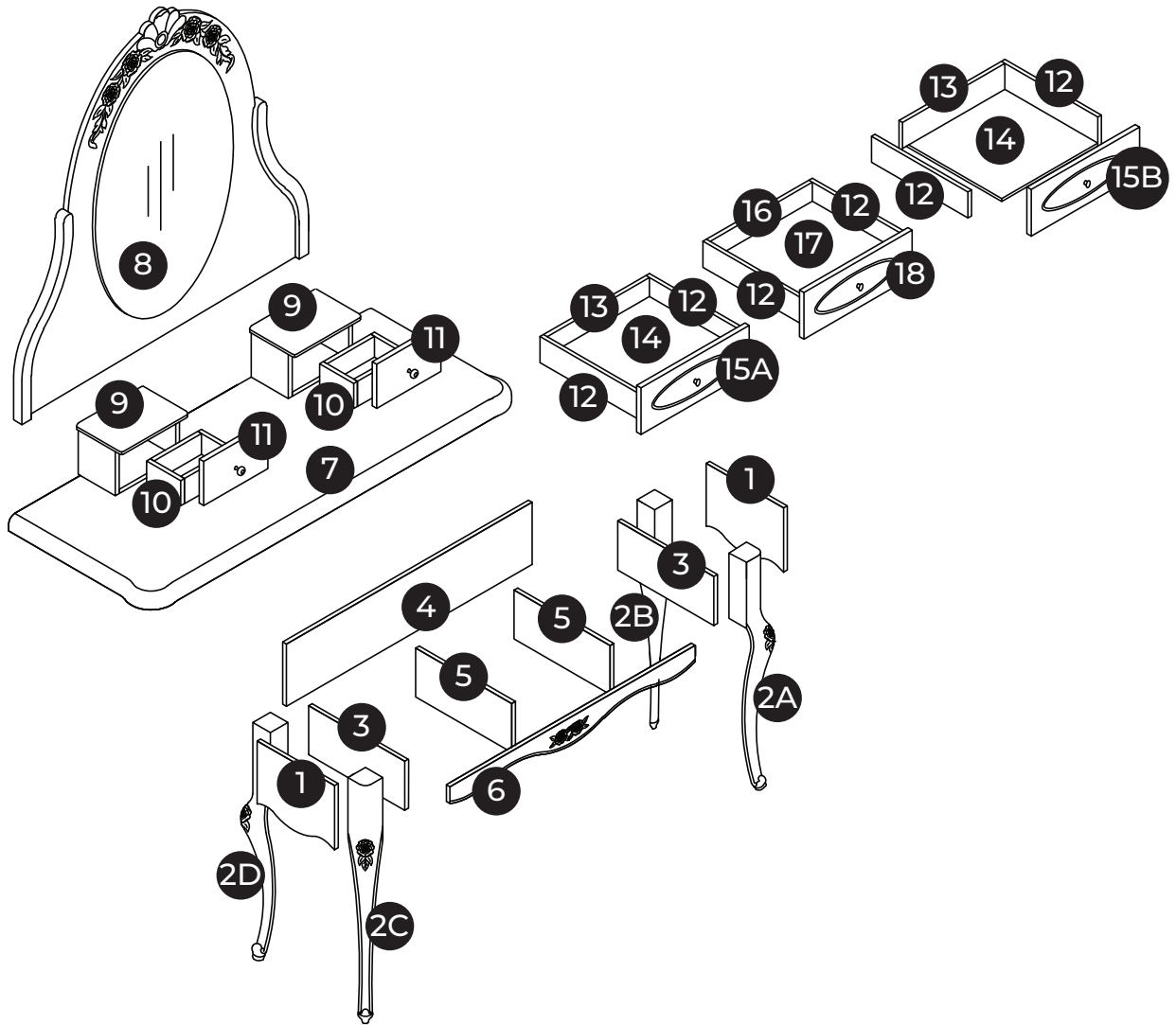

**A** x49  
 Ø 15 mm



**B** x6  
 Ø 8 x 30 mm



**C** x5



**D** x3  
 Ø 4 x 25 mm



**E** x2  
 Ø 4 x 18 mm



**F** x44  
 Ø 3,5 x 15 mm



**G** x12  
 Ø 3,5 x 35 mm

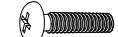

**H** x4  
 Ø 6 x 20 mm



**I** x4  
 Ø 6 x 50 mm

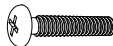

**J** x12  
 Ø 6 x 25 mm

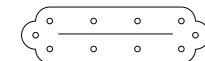

**K** x2  
 250 x 40 mm



**S** x6  
 350x35 mm

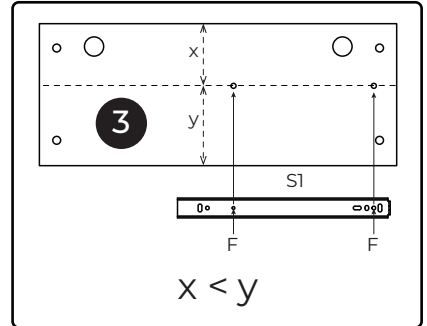
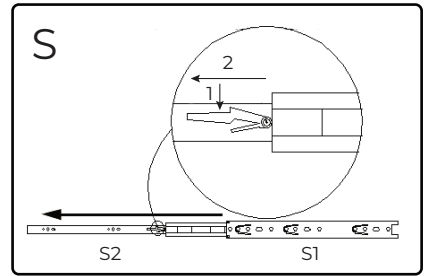
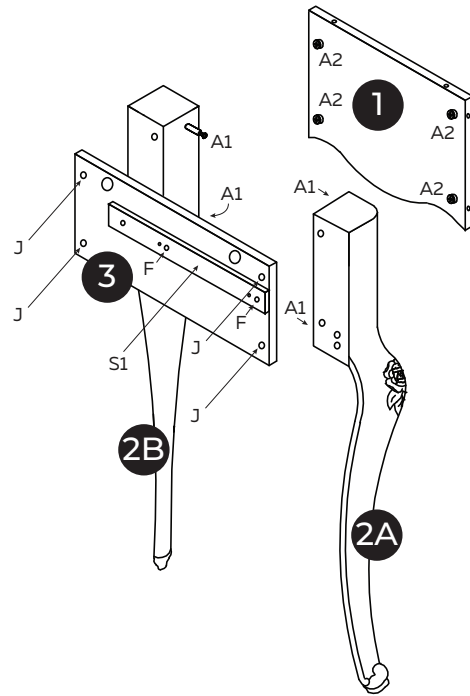
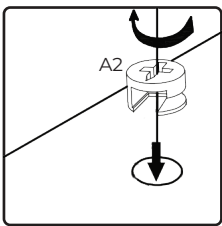
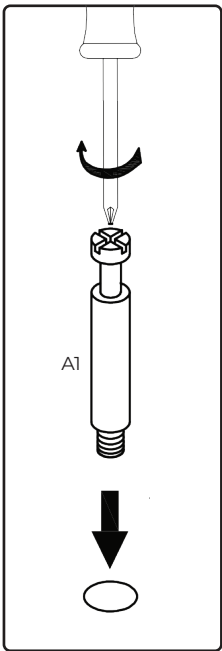

x2

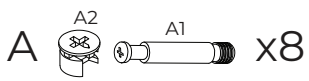

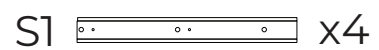
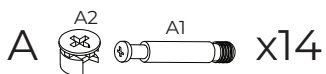
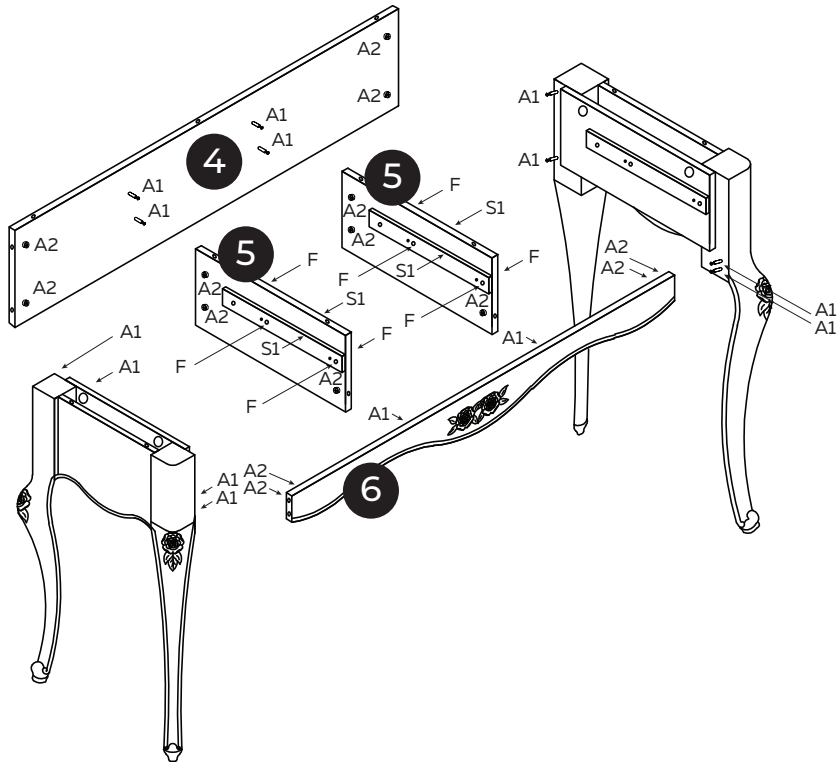

1

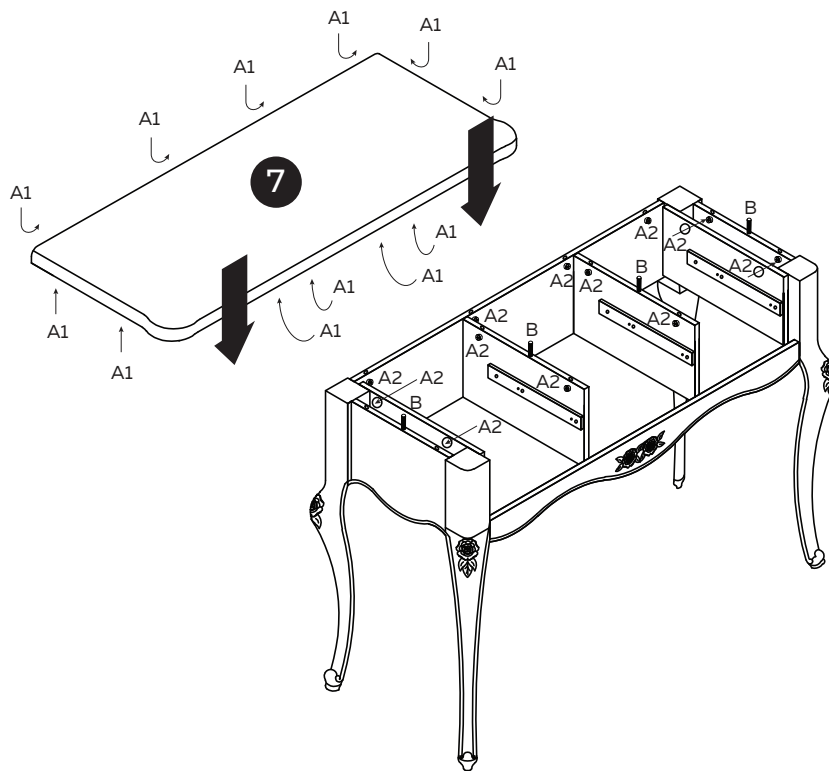

2





A   x12

B  x4

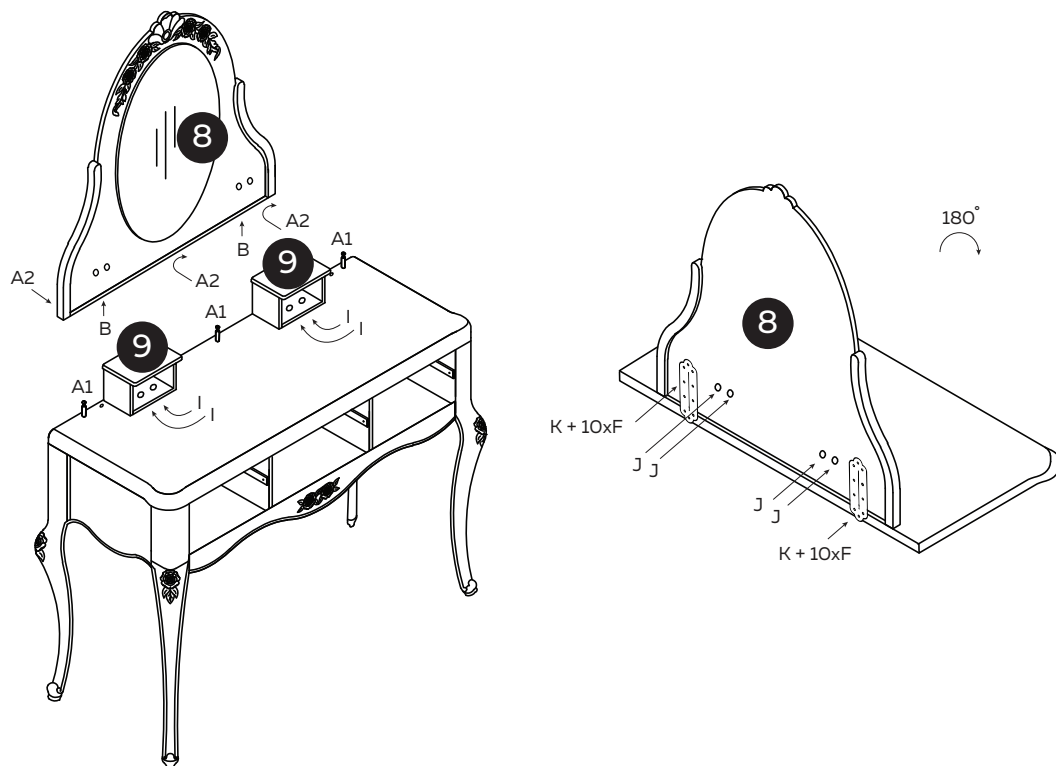
3



A   x3

B  x2

F  x20

I  x4

J  x4

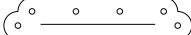
K  x2

4

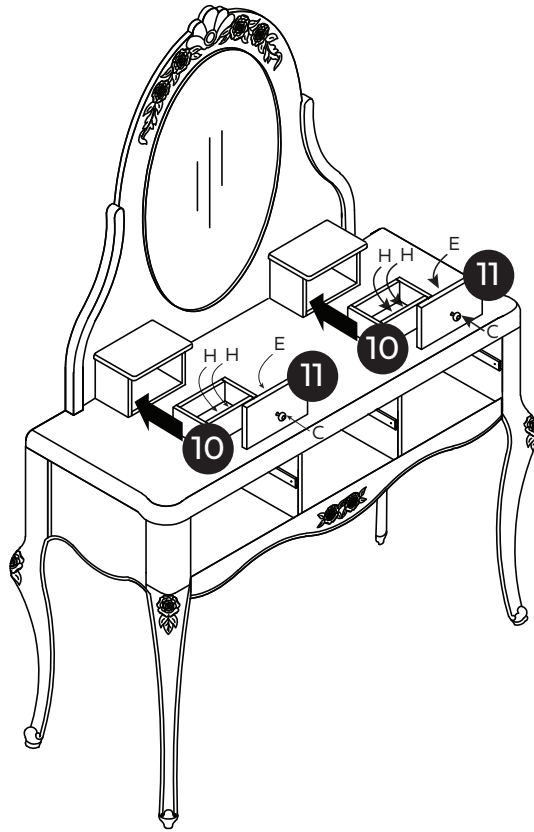

C  x2

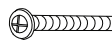
E  x2

H  x4

5

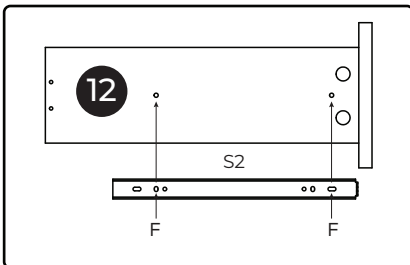

x6

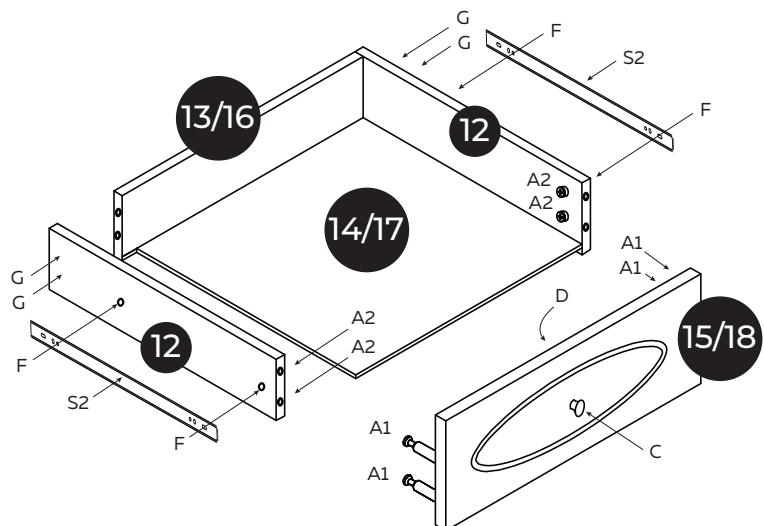
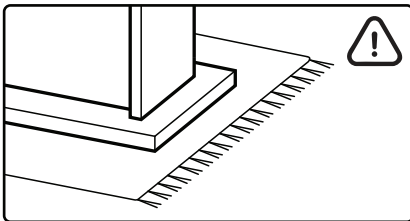
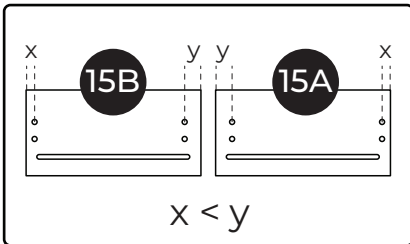

x3

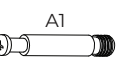
A   x12

C  x3

D  x3

F  x12

G  x12

S2  x6

6

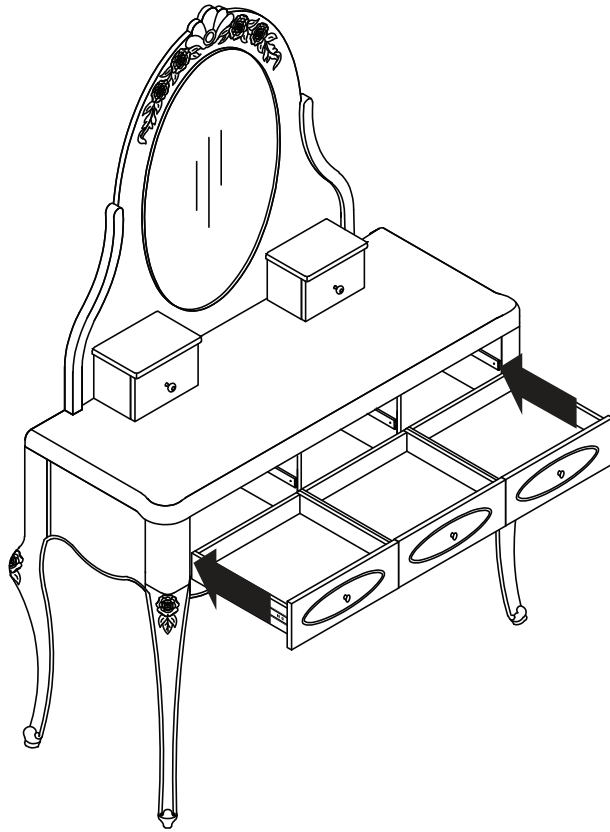

7

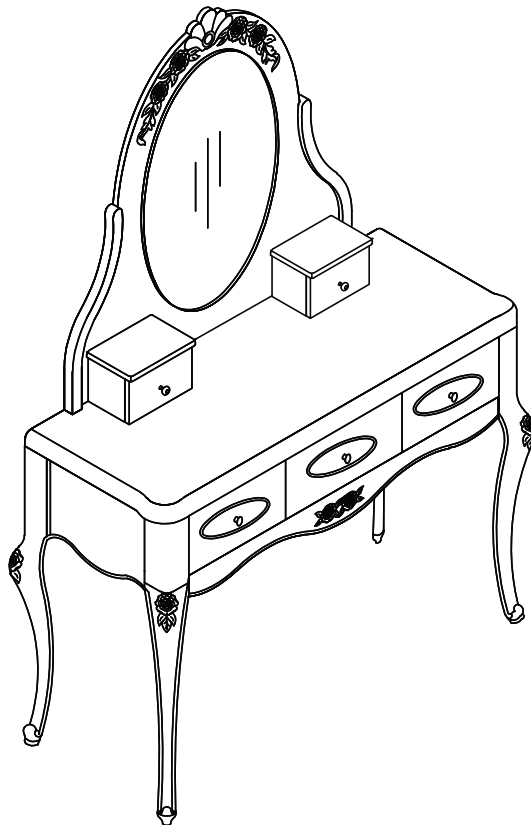

8